

**Rilevatore Gas industriale, con cartuccia sensore sostituibile Certificato ATEX per zona 1**  
*Industrial gas detector, with replaceable cartridge sensor ATEX certified for Zone 1*

I rilevatori di gas in custodia antideflagrante per l'impiego in aree con presenza d'atmosfera potenzialmente esplosive, certificati **CESI 03 ATEX 323 X** (EN60079-0 ed EN60079-1) sono caratterizzati dalla seguente marcatura ATEX (Direttiva 2014/34/UE):

*The gas detectors in explosion proofhousing for use in potentially explosive atmospheres are certificated **CESI 03 ATEX 323 X** (EN60079-0 ed EN60079-1) and characterized by the following EX marking (Directive 2014/34/UE):*

CE 0722  II 2 G Ex db IIC T6 Gb



Filmato  
Video





Istruzioni d'uso  
User's Manual









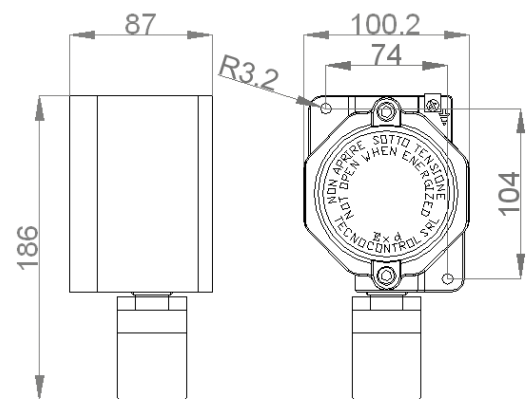

Certificazione  
Certification

**TS293**

- Alimentazione: 12÷24 Vcc
  - Marcatura ATEX  : II 2G Ex d IIC T6 Gb
  - No. 1 uscita lineare 4÷20 mA
  - Morsetti ad innesto polarizzati
- 
- Power supply: 12÷24 Vdc
  - Ex marking  : II 2G Ex d IIC T6 Gb
  - No. 1 linear 4÷20 mA current output
  - Terminals plug-in polarized type



Codice Code	Gas rilevato Gas detected	Cartuccia ricambio Cartridge replacement	Campo misura Measuring range	Bombola taratura Calibration cylinder	Vita media in aria pulita Average time in clean air	Prezzo Price	Tecnologia Technology
TS293KM	Metano - Natural gas	ZSK01/EX	0÷20% LFL	B0200	5 anni/years	€ 608,70	  
TS293KG	GPL - LPG	ZSK01/EX	0÷20% LFL	B0200	5 anni/years	€ 608,70	
TS293KI	Idrogeno - Hydrogen	ZSK02/EX	0÷20% LFL	B0200	5 anni/years	€ 608,70	
TS293KB	Benzina - Petrol	ZSK04/EX	0÷20% LFL	B0200	5 anni/years	€ 608,70	
TS293PM	Metano - Natural gas	ZSP05/EX	0÷100% LFL	B0200	5 anni/years	€ 688,70	
TS293PG	GPL - LPG	ZSP05/EX	0÷100% LFL	B0200	5 anni/years	€ 688,70	  
TS293PI	Idrogeno - Hydrogen	ZSP05/EX	0÷100% LFL	B0200	5 anni/years	€ 688,70	
TS293PB	Benzina - Petrol	ZSP05/EX	0÷100% LFL	B0200	5 anni/years	€ 688,70	
TS293PE	Acetilene - Acetylene	ZSP02/EX	0÷100% LFL	B0200	5 anni/years	€ 884,10	
TS293PS	Stirene - Styrene	ZSP03/EX	0÷100% LFL	B0200	5 anni/years	€ 927,60	
TS293PX	Vedi tabella 1 - See Table 1	ZSP05/EX	0÷100% LFL	B0200	5 anni/years	€ 688,70	  
TS293PX-H	Vedi tabella 2 - See Table 2	ZSP02/EX	0÷100% LFL	B0200	5 anni/years	€ 884,10	
TS293EA	Ammoniaca - Ammonia	ZSEA1/EX	0÷300 ppm	B0501	2 anni/years	€ 1.075,10	
TS293EA-H	Ammoniaca - Ammonia	ZSEA2/EX	0÷300 ppm	B0501	2 anni/years	€ 1.614,60	
TS293EC-S	Ossido di carbonio - Carbon monoxide	ZSEC1/EX	0÷300 ppm	B0210	3 anni/years	€ 727,80	
TS293EC-H	Ossido di carbonio - Carbon monoxide	ZSEC2/EX	0÷300 ppm	B0210	2 anni/years	€ 1.202,10	
TS293EH	Idr. solforato - Hydrogen sulphide	ZSEH1/EX	0÷100 ppm	B0420	2 anni/years	€ 1.208,20	
TS293EHCN	Acido cianidrico - Hydrogen cyanide	ZSEHCN/EX	0÷10 ppm	B0479	2 anni/years	€ 1.434,90	
TS293EN	Ossido di azoto - Nitrogen monoxide	ZSEN1/EX	0÷300 ppm	B0472	2 anni/years	€ 1.302,70	
TS293EN2	Biossido di azoto - Nitrogen dioxide	ZSEN2/EX	0÷30 ppm	on request	2 anni/years	€ 1.050,90	
TS293ES	Anidride solforosa - Sulphur dioxide	ZSES1/EX	0÷20 ppm	B0468	2 anni/years	€ 1.314,30	
TS293EO	Ossigeno - Oxygen	ZSE01/EX	0÷25% Vol.	B0416	2 anni/years	€ 927,20	